

PAIR DOOR FRAME ELEVATION
SCALE: 1/2" = 1'-0"

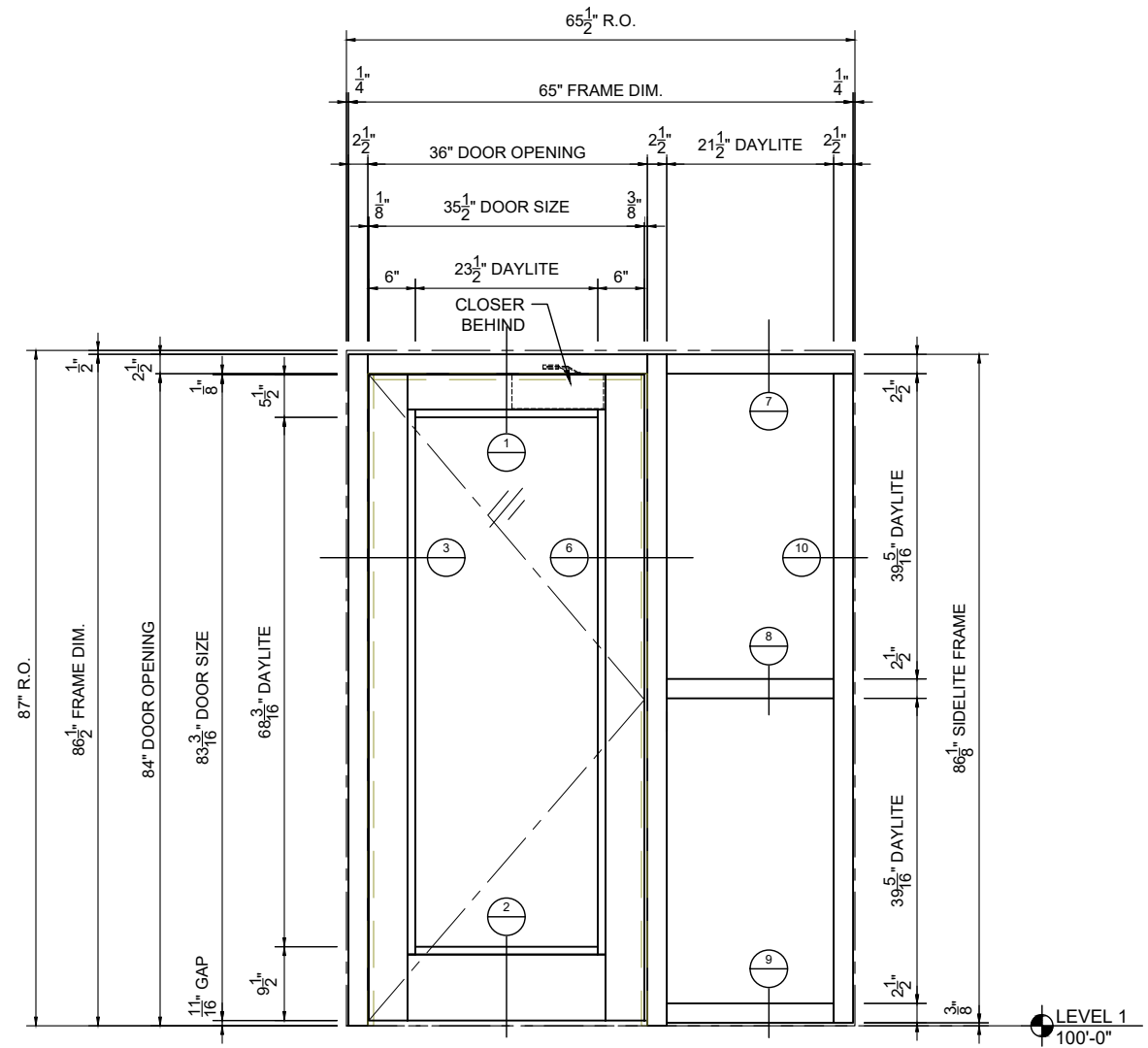

SINGLE DOOR FRAME ELEVATION
SCALE: 1/2" = 1'-0"

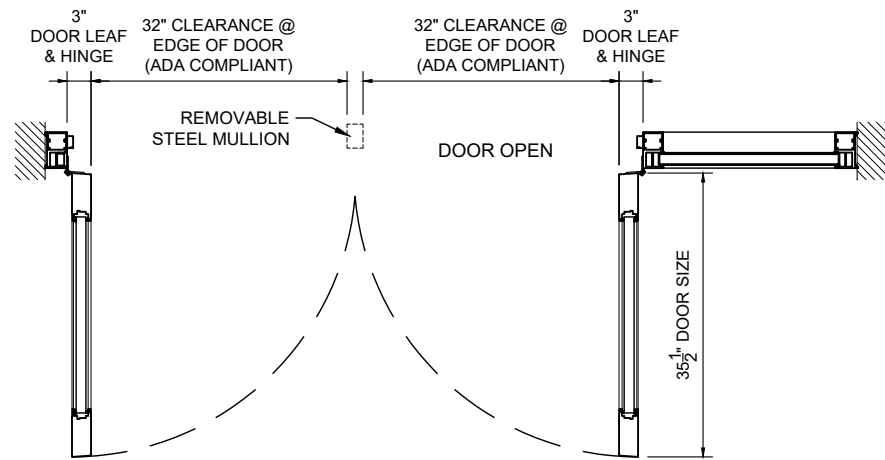

PAIR DOOR FRAME PLAN

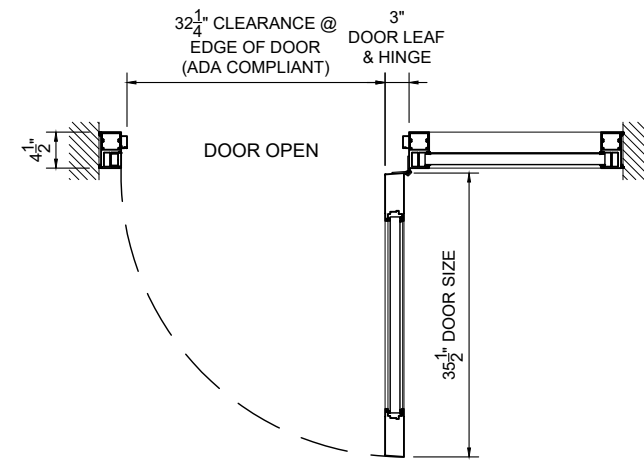

SINGLE DOOR FRAME PLAN

SHEET NUMBER:
1 of 3
JOB NUMBER:

44-350 + 44-450
ELEVATIONS
SALES DRAWING

REVISIONS:	NO.	DATE	DESCRIPTION

SCALE:	AS INDICATED
DRAWN BY:	
DATE:	

INSULGARD SECURITY PRODUCTS
1291 RICKETT ROAD BRIGHTON, MI 48116
PHONE (810) 844 - 0776 FAX (810) 844 - 0920

DISCLAIMER: THE INFORMATION CONTAINED IN THIS DRAWING IS CONFIDENTIAL. IT IS THE EXCLUSIVE PROPERTY OF "INSULGARD". AUTHORIZED USE MUST BE APPROVED BY "INSULGARD". ANY UNAUTHORIZED REPRODUCTION AND/OR DISTRIBUTION IS PROHIBITED.

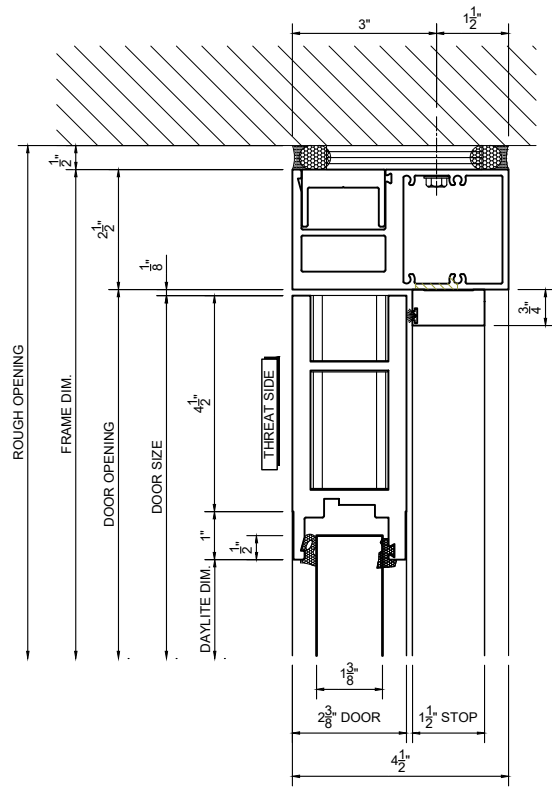

1 DOOR HEAD DETAIL
SCALE: 3" = 1'-0"

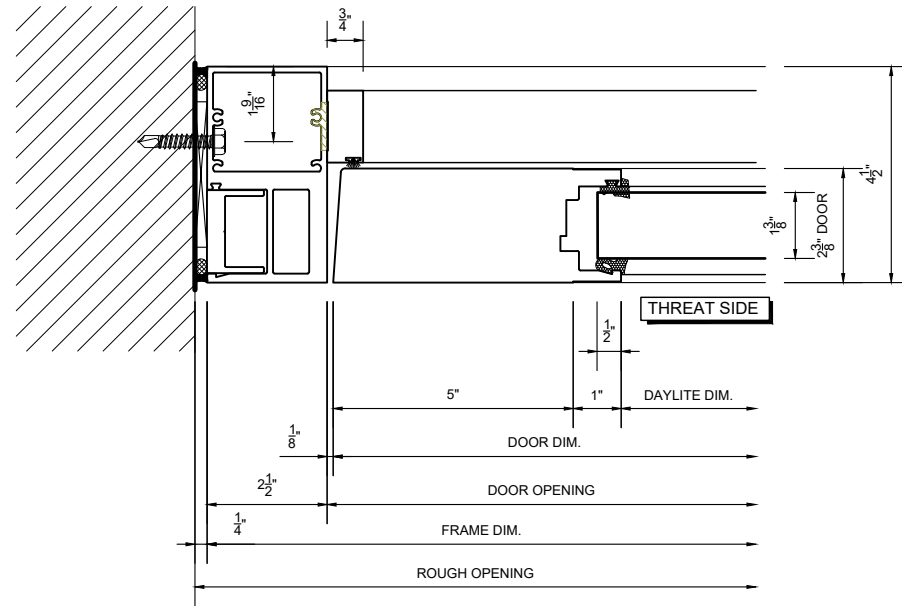

3 DOOR JAMB DETAIL (STRIKE)
SCALE: 3" = 1'-0"

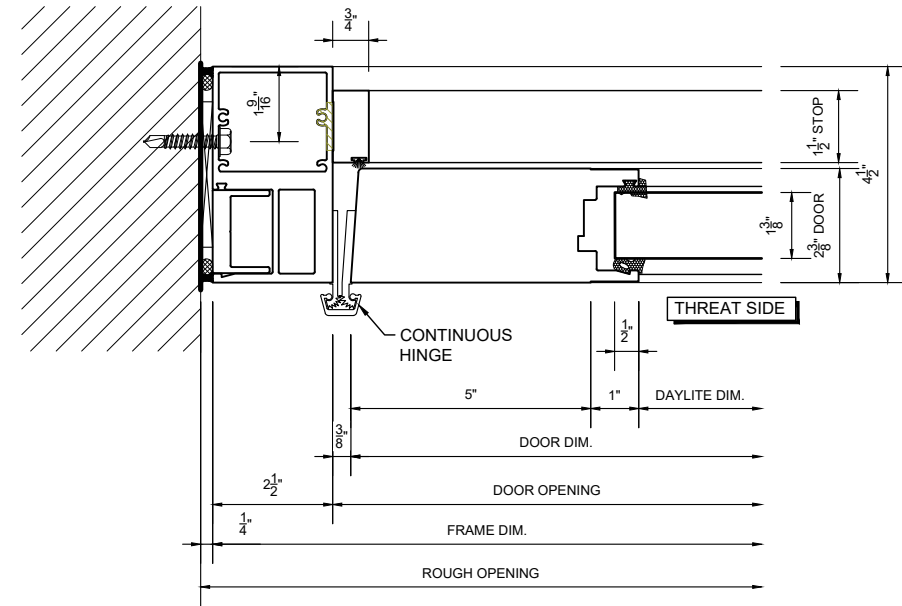

5 DOOR JAMB DETAIL (HINGE)
SCALE: 3" = 1'-0"

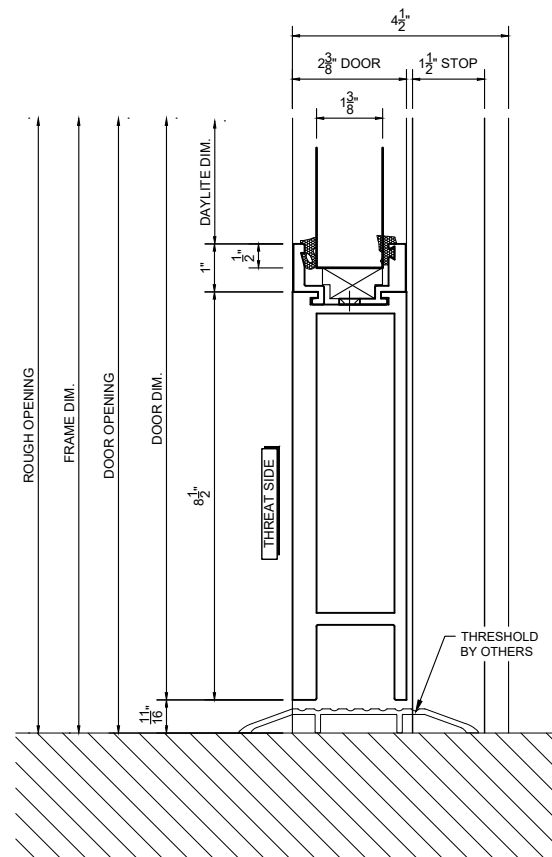

2 DOOR BOTTOM DETAIL
SCALE: 3" = 1'-0"

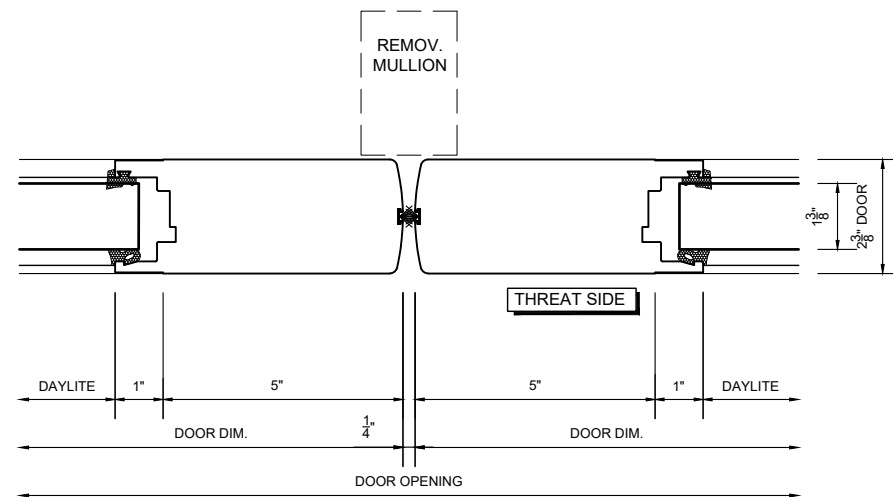

4 MEETING STILE DETAIL
SCALE: 3" = 1'-0"

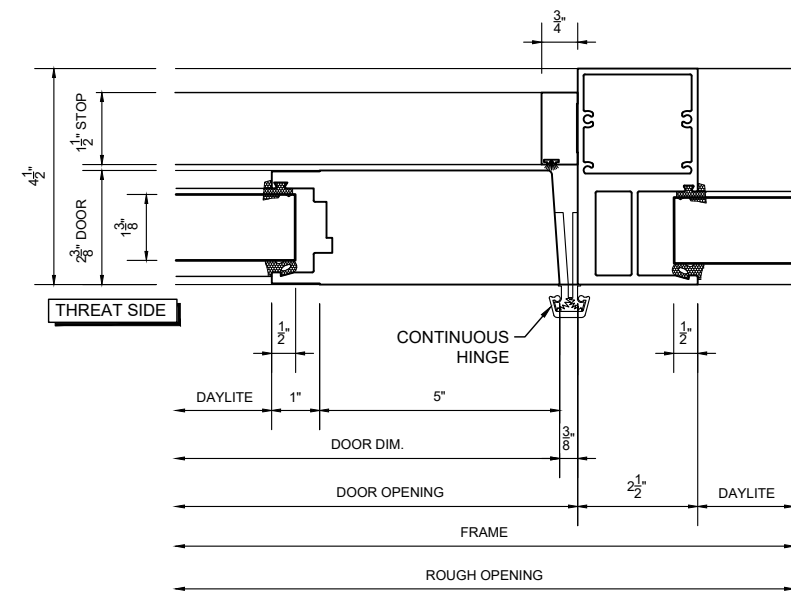

6 DOOR @ HINGE TO JAMB W/ SIDELITE
SCALE: 3" = 1'-0"

SHEET NUMBER:
2 of 3
JOB NUMBER:

44-350 + 44-450
DETAILS
SALES DRAWING

REVISIONS:	NO.	DATE	DESCRIPTION

SCALE: AS INDICATED	DRAWN BY:	DATE:
------------------------	-----------	-------

INSULGARD
SECURITY PRODUCTS
1291 RICKETT ROAD
BRIGHTON, MI 48116
PHONE (810) 844 - 0776
FAX (810) 844 - 0920

DISCLAIMER: THE INFORMATION CONTAINED IN THIS DRAWING IS CONFIDENTIAL. IT IS THE EXCLUSIVE PROPERTY OF "INSULGARD". AUTHORIZED USE MUST BE APPROVED BY "INSULGARD". ANY UNAUTHORIZED REPRODUCTION AND/OR DISTRIBUTION IS PROHIBITED.

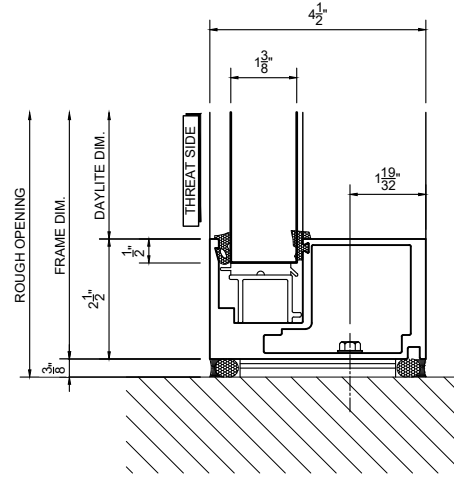

9 SILL DETAIL
SCALE: 3" = 1'-0"

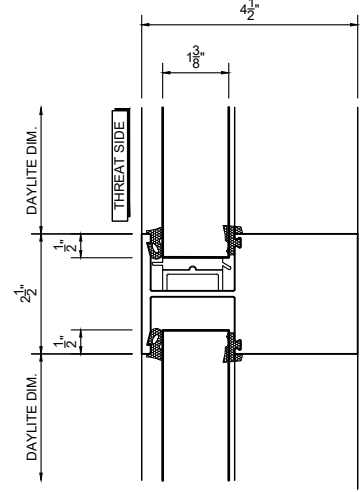

8 1PC INT. HORIZONTAL
SCALE: 3" = 1'-0"

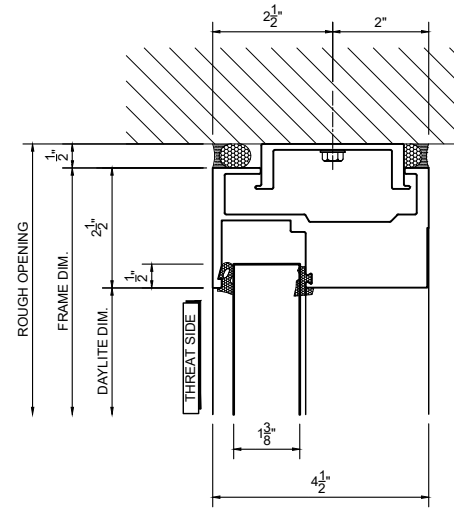

7 HEAD DETAIL
SCALE: 3" = 1'-0"

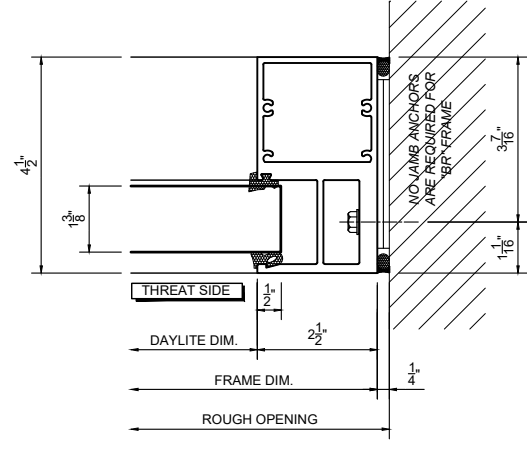

10 JAMB DETAIL
SCALE: 3" = 1'-0"

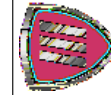

1291 RICKETT ROAD
PHONE (810) 844 - 0776
BRIGHTON, MI 48116
FAX (810) 844 - 0920

DISCLAIMER: THE INFORMATION CONTAINED IN THIS DRAWING IS CONFIDENTIAL. IT IS THE EXCLUSIVE PROPERTY OF "INSULGARD". AUTHORIZED USE MUST BE APPROVED BY "INSULGARD". ANY UNAUTHORIZED REPRODUCTION AND/OR DISTRIBUTION IS PROHIBITED.

SCALE:
AS INDICATED
DRAWN BY:
DATE:

REVISIONS:
NO. DATE DESCRIPTION

44-350 + 44-450
DETAILS
SALES DRAWING

SHEET NUMBER:
3 of 3
JOB NUMBER:

LOCATION: